

1 Unilift KP 150 A 1



: 011H1800

F

10 m

10 mm

: 0.. 50 °C

998.2 kg/m³

: 10 mm

Ташев-Галвинг ООД
www.tashev-galving.com

011H1800 Unilift KP 150 A 1 50 Hz

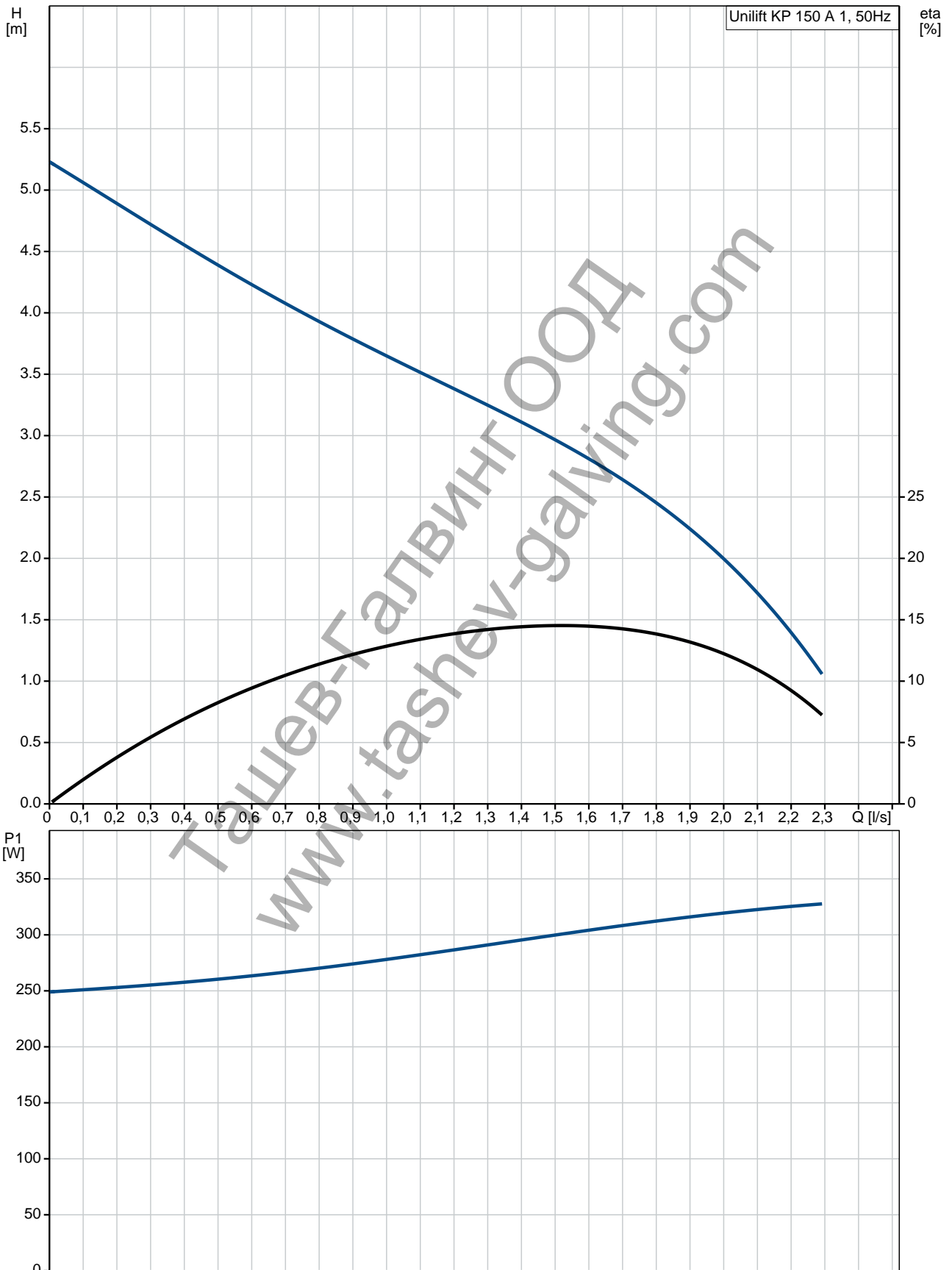

:		Unilift KP 150 A 1
No.:	:	011H1800
EAN	:	5700391115523
:		
Maximum flow:	:	2.36 l/s
:	:	2.36 l/s
:	:	5.5 m
:	:	10 mm
:	:	A
:		
:	:	DIN W.-Nr. 1.4301
:	:	AISI 304
:	:	
:	:	DIN W.-Nr. 1.4031
:	:	AISI 304
:		
:	:	Rp 1 1/4
:	:	7 m
:		
:	:	
:	:	0 .. 50 °C
:	:	998.2 kg/m ³
:	:	
- 1:	:	300 W
:	:	50 Hz
:	:	1 x 220-230 V
:	:	1.3 A
:	:	8 µF/400 V
:	:	
(IEC 34-5):	:	IP68
(IEC 85):	:	F
:	:	
:	:	10 m
:	:	SCHUKO
:		
:	:	
:	:	6.5 kg
:	:	6.7 kg
:	:	0.013 m ³
VVS	:	391215016
RSK	:	5885711
LVI	:	4822503
NRF	:	9040752
:	:	HU
:	:	84137021

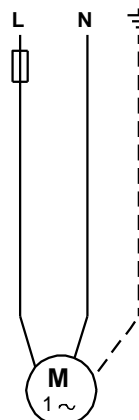
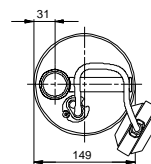
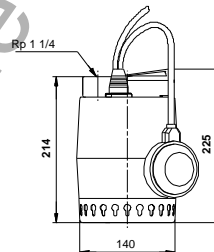
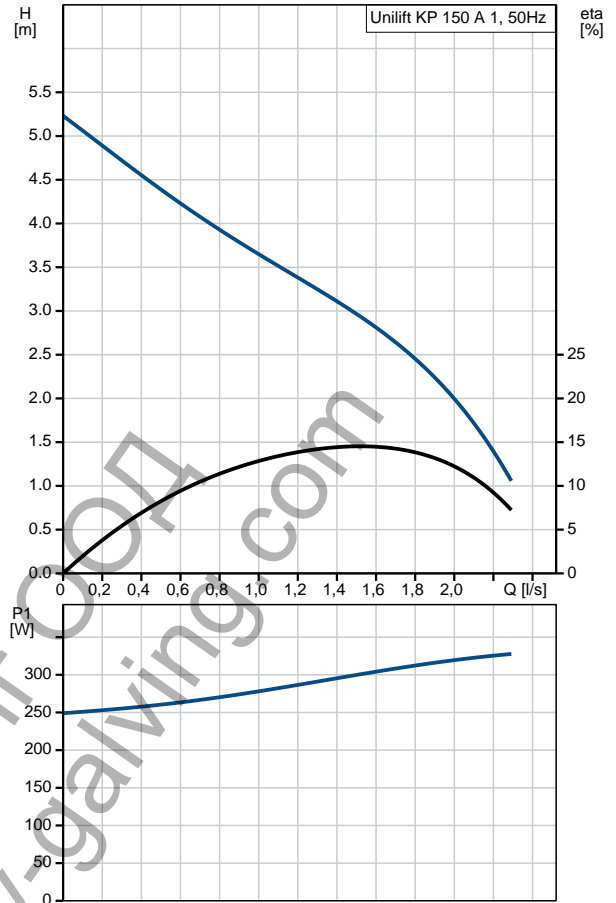

011H1800 Unilift KP 150 A 1 50 Hz

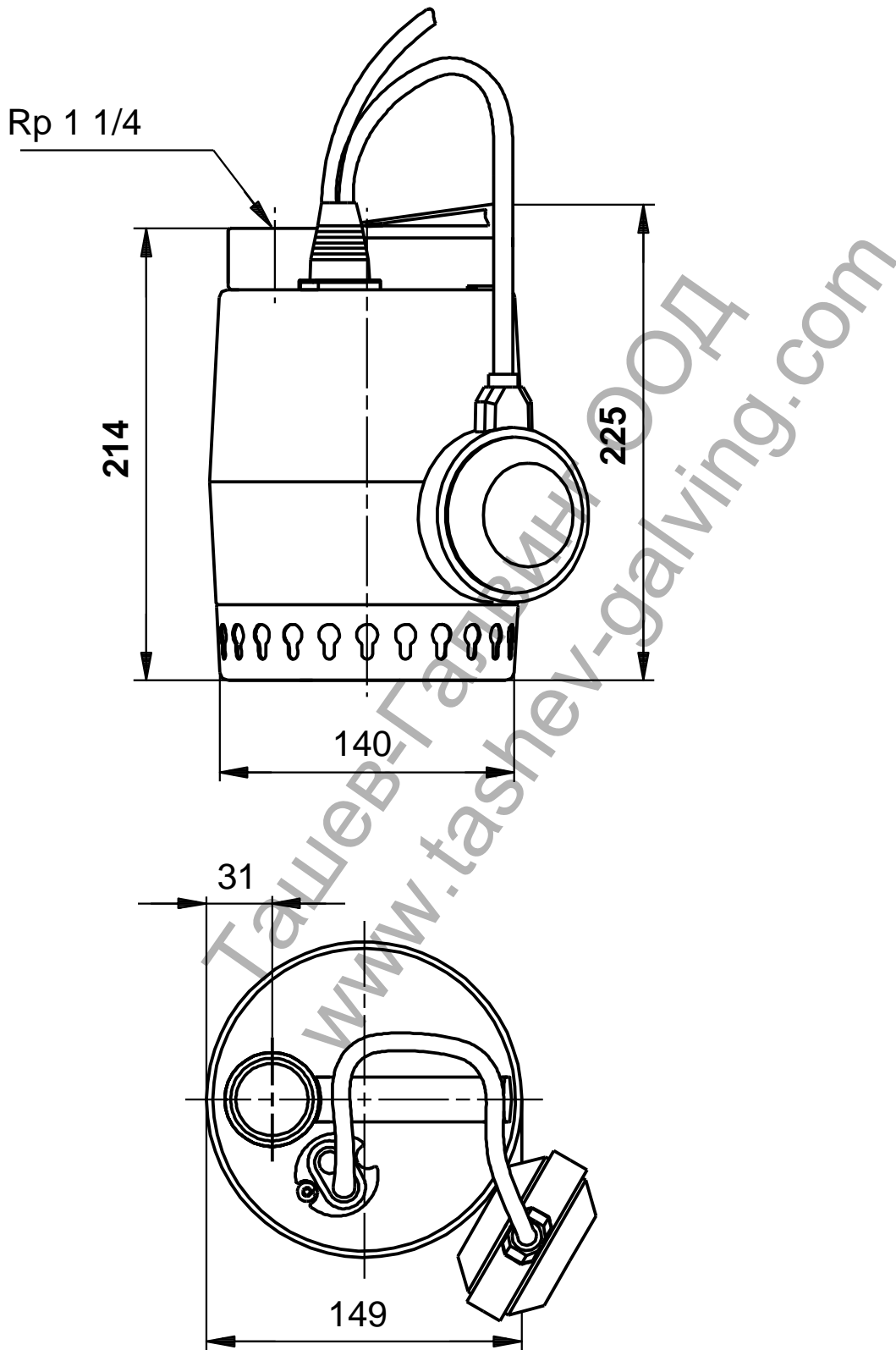

! [mm],

011H1800 Unilift KP 150 A 1 50 Hz

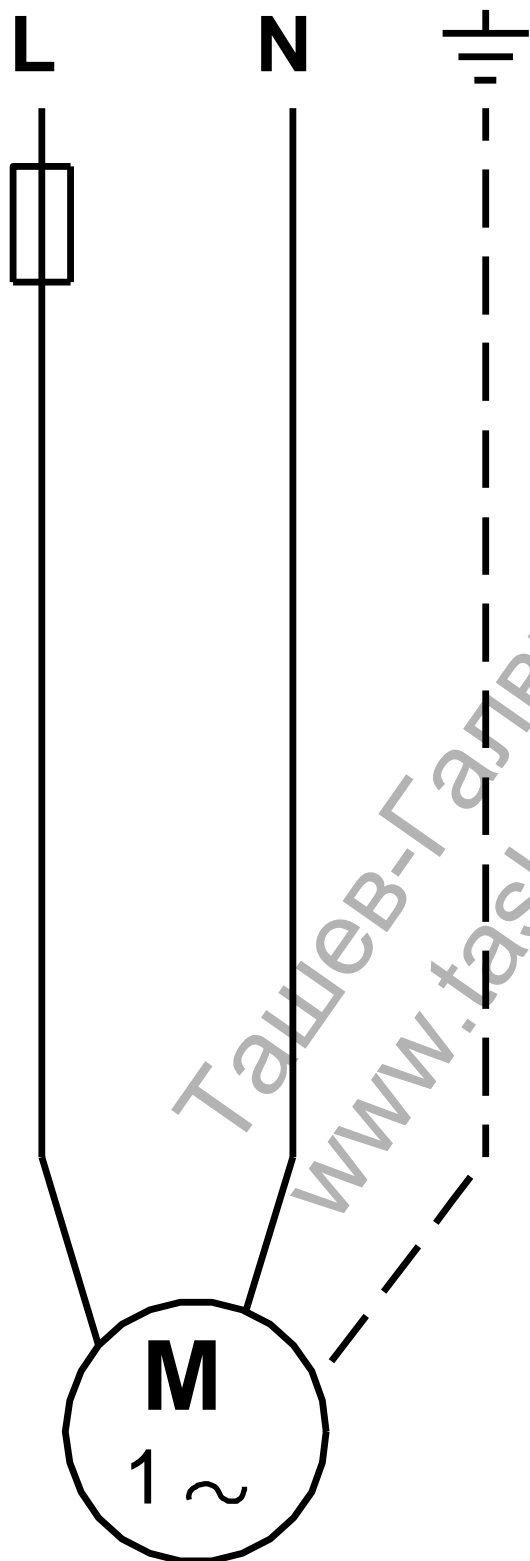

!

[mm],

:
: Unilift KP 150 A 1
: 1
: 011H1800

Ташев-Галвинг ООД
www.tashev-galving.com